



GENERAL FEATURES

- Environmentally friendly
- Thick plate with high Tin low Calcium alloy
- High Reliability and Good Quality
- Deep Discharge Recovery
- High Power Density
- Long Service Life, in Float or Cyclic

APPLICATIONS

- Solar & Wind energy system
- Cable TV Systems
- Telecom systems
- Wheel chair & Golf Car
- Marine Equipment
- Railway Systems
- Emergency Power System



DIMENSIONS & WEIGHT

Length(mm)	152±1
Width(mm)	99±1
Height(mm)	96±1
Total Height(mm)	102±1
Weight(kg)	3.8±3%

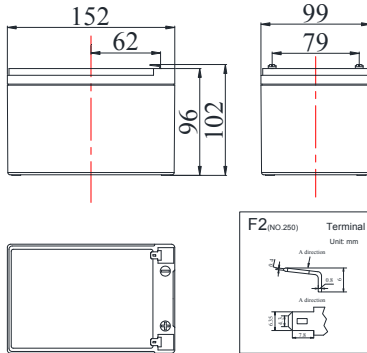

COMPLIED STANDARDS

IEC 60896-21/22	JIS C8704
YD/T799	BS6290 part4
GB/T 19638	UL 1989

TECHNICAL SPECIFICATIONS

Art. no: TRAD12-14

Nominal Voltage		12V(6 cells per unit)
Design Floating Life @25°C		6 Years
Nominal Capacity @25°C(20 hour rate@0.70A,10.50V)		14Ah
Capacity @25°C	10 hour rate (1.32A,10.8V)	13.20Ah
	5 hour rate (2.50A,10.5V)	12.50Ah
	1 hour rate (9.14A,9.6V)	9.14Ah
Internal Resistance	Full Charged Battery@25°C	≤15.0mΩ
Ambient Temperature	Discharge	-20°C~50°C
	Charge	-20°C~50°C
	Storage	-20°C~50°C
Max.Discharge Current@25°C		210A(5s)
Capacity affected by Temperature (10 hr Capacity)	40°C	102%
	25°C	100%
	0°C	85%
	-15°C	65%
Self-Discharge@25°C per Month		3%
Charge (Constant Voltage) @25°C	Standby Use	Initial Charging Current Less than 3.78A Voltage 13.6-13.8V
	Cycle Use	Initial Charging Current Less than 3.78A Voltage 14.4-14.9V

BATTERY DISCHARGE TABLE

Discharge Constant Current per Cell (Amperes at 25°C)

F.V/Time	5min	10min	15min	30min	45min	1h	2h	3h	5h	8h	10h	20h
1.60V	58.0	36.6	26.9	15.97	11.64	9.14	5.78	3.96	2.64	1.77	1.40	0.740
1.67V	54.9	35.1	26.3	15.70	11.45	8.84	5.68	3.88	2.60	1.74	1.38	0.726
1.70V	52.0	33.2	26.0	15.49	11.31	8.56	5.56	3.82	2.54	1.70	1.36	0.714
1.75V	49.6	31.7	24.6	14.98	11.01	8.30	5.46	3.74	2.50	1.69	1.34	0.700
1.80V	45.8	29.5	22.9	14.38	10.65	8.06	5.26	3.60	2.40	1.64	1.32	0.692

Discharge Constant Power per Cell (Watts at 25°C)

F.V/Time	5min	10min	15min	30min	45min	1h	2h	3h	5h	8h	10h	20h
1.60V	104.06	70.32	52.00	31.06	22.72	17.98	11.34	7.81	5.23	3.53	2.81	1.476
1.67V	99.72	67.47	51.00	30.62	22.42	17.36	11.14	7.67	5.13	3.49	2.78	1.454
1.70V	95.62	63.82	50.42	30.28	22.20	16.74	10.93	7.52	5.05	3.43	2.76	1.436
1.75V	91.60	60.93	47.84	29.36	21.66	16.12	10.73	7.38	4.94	3.40	2.71	1.406
1.80V	85.40	56.99	44.72	28.28	21.00	15.50	10.30	7.09	4.76	3.31	2.69	1.400





PERFORMANCE CHARACTERISTICS

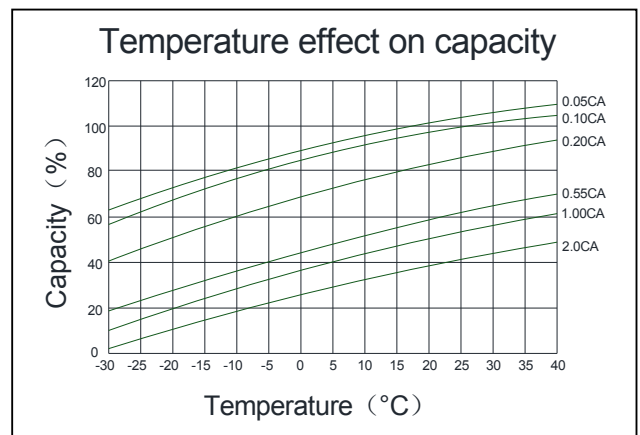
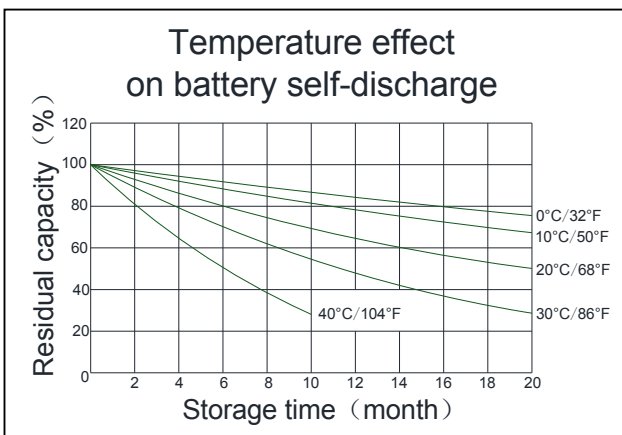
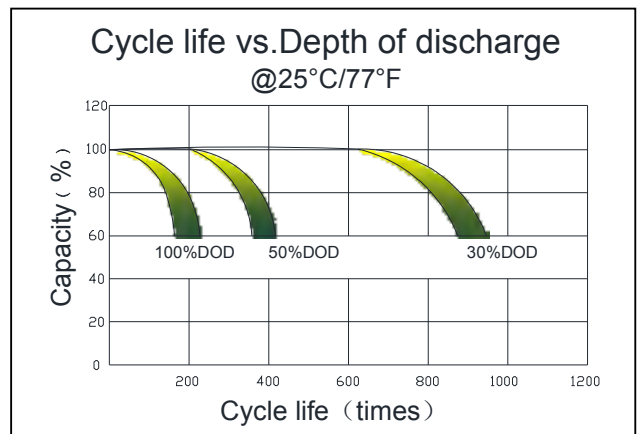
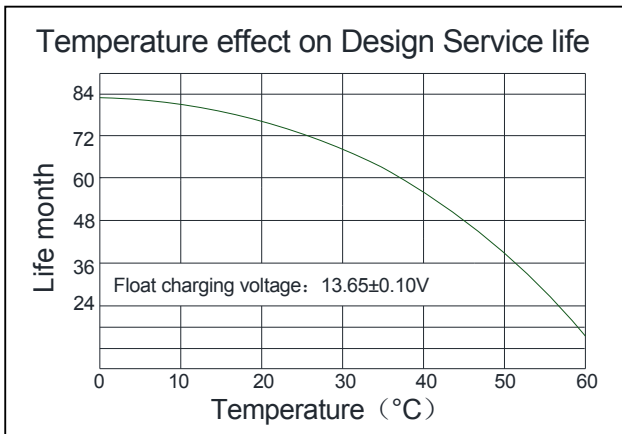
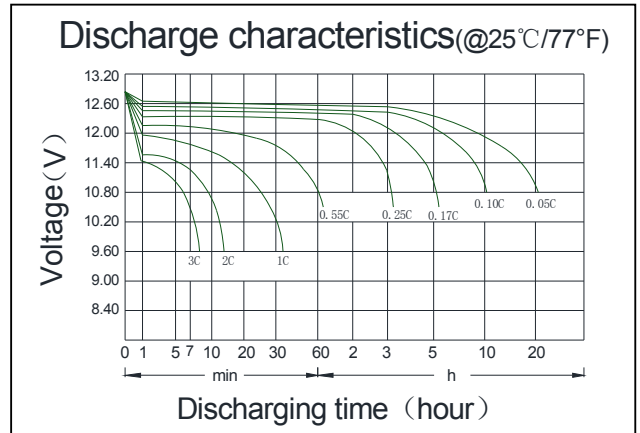
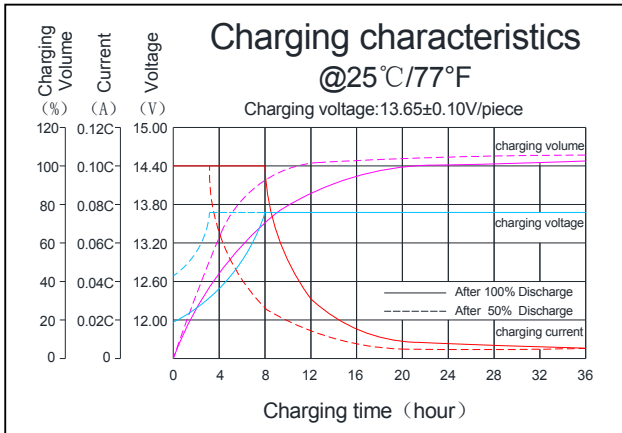

BATTERY CONSTRUCTION

Component	Positive plate	Negative plate	Container & Cover	Safety valve	Terminal	Separator	Electrolyte	Pillar seal
Features	Thick high Sn low Ca grid with special paste	Balanced Pb-Ca grid for improved recombination efficiency	ABS (UL94-V0 optional)	Flame Si-Rubbeand aging resistanter	Female Copper Insert (F1/F2)	Advanced AGM separator for high pressure cell design	Dilute high purity sulphuric acid	Two layers epoxy resin seal

